

Data Sheet

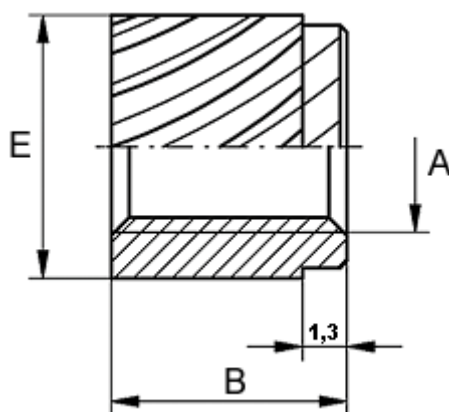

Article number: 12890000035100
Description: KLEE-coil 890 000 035.100
M3,5 Hardened/zinc-pl.

Measures



Female thread A	= M3,5
Length B	= 5.6
Min material thickness	= 2.2
Outer diameter E	= 6.2
Recommended bore diameter	= 5.7
Type	= 890 000 035.100